

Harvest Price List - 2023-2024





SCHUMACHER "EASY CUT" CUTTING SYSTEM

The Schumacher EASY-CUT Cutting System is commonly fitted as original equipment on many brands, including Claas, Deutz & HoneyBee. It was designed and built as a strong & robust cutting system capable of handling the heavy crops in Western Europe.

The Schumacher Cutting System is modular by design: adaptable to almost any header front available in Australia. The system comprises three main components: the Guards - welded, and bolted top and bottom; the wear bars or bridge rollers; and the knife back.

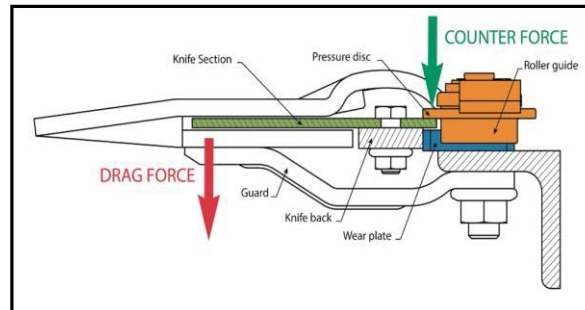

The knife back is carried on wearbars or bridge rollers, which may be easily and economically changed as required. This allows for extended use of the guards. Sections are bolted "one up, one down". As the knife passes the anvil of the guard, one section will pull the knife up, the next will pull the knife down, which in turn results in a more balanced knife operation, reduced load and stress on the knife drive, superior cutting performance, and a more even wear across the guards & knife.





HARVEST PRICE LIST INDEX

	Page
GUARDS - (Schumacher, Crary, MacDon & New Holland).....	1&2
SECTIONS & FASTENERS.....	3
KNIFE KITS (Overlap, Connector & Repair).....	4
KNIFE SEGMENTS (for Knife Sets) & KNIFE BACKS.....	5
REPLACEMENT KNIFE SETS.....	6
CONVERSION KITS (Schumacher Premium & Comfort).....	7
WEARBARS, ROLLERS & SPACER PLATES.....	8
KNIFE HEADS AND COMPONENTS.....	9
PRO DRIVES AND COMPONENTS.....	10
CROPLIFTERS (Standard) & ACCESSORIES.....	11
<i>PRO FLEX</i> LIFTERS, MOUNTING KITS & INSTRUCTIONS.....	12-14
BOLT KITS FOR MOWER BLADES.....	15
MOWER BLADES.....	16-19





KNIFE GUARDS

Part No.	Description	Midwest No.	OEM No.	HoneyBee No.	RRP \$\$ per ea
----------	-------------	-------------	---------	--------------	-----------------

KNIFE GUARDS - SCHUMACHER

Standard Double Guard					
84016500	Two Finger Guard - 12mm Black - <i>Easy Cut II System</i>	816-00064-06	86561686	61694	
84016501	Two Finger Guard - 14mm Oxide Red - <i>Easy Cut II System</i>				
84016502	Two Finger Guard - 17mm Grey - <i>Easy Cut II System</i>				



Triple - Three Finger Guard					
84016503	Triple Finger Guard - 12mm Black - <i>Easy Cut II System</i>		86561687	62594	
84016504	Triple Finger Guard - 14mm Oxide Red - <i>Easy Cut II System</i>				



Open Top First / Knife-Head Guard					
84010701	Open Top First/Head Guard - 12mm Black	816-00063-06	86561684	26450	
84010702	Open Top First/Head Guard - 14mm Oxide Red				



Open Top Centre Guard (for twin knife systems)					
84010637	Open Top Centre Guard for Overlap 12mm Black	816-00065-06	86564361	26751	
84010638	Open Top Centre Guard for Overlap 14mm Oxide Red				

KNIFE GUARDS - "CRARY" PREMIUM

"Crary" No Choke					
84052597	"Crary" 7228 "No-Choke" Guard Double Hardened to 58 - 62 HRC - <u>*GREAT VALUE*</u>		86561624	26604	
84001546	"Crary" / "No-Choke" Centre Overlap Guard (Three required per twin drive set-up)				





KNIFE GUARDS

Part No.	Description	Midwest No.	OEM No.	Alternate No.	RRP \$\$ per ea
KNIFE GUARDS - JOHN DEERE, MACDON, NEW HOLLAND etc.					
<u>JOHN DEERE PREMIUM - Double Hardened</u>					
84053427	Long/Short/Long Guard to suit John Deere - Long Life (55-63 HRC)		H229539	H213405DH	
84053565	Short/Long/Short Guard to suit John Deere - Long Life (55-63 HRC)		H229540	#	
84218703	Three finger open top "non Clog" guard to suit John Deere		H218703	**SPECIAL**	
<u>MACDON</u>					
84053064	MacDon Standard Guard - suits 962/1040/1042, D50, D60, FD70, FD1		118484 WN-118344	87421451	
84553391	MacDon Centre Guard - Lower		118346		
84553392	MacDon End Guard - Left		118301		
84553393	MacDon End Guard - Right		118302		
<u>NEW HOLLAND</u>					
84042849	New Holland, Hesston etc - suits Case 1010, Early MacDon 1040/1042	816-00051-06	86615982	86521587 49239H B 4215	
84042850	New Holland *New* Double 6" Guard (New Holland latest style guard) Suits New Holland 840CD & 880CF Suits Case 3152 & 3162		379720	42841	
KNIFE - HOLD DOWN CLAMP					
85151270	Knife Hold Down Clamp High Arch		<i>Priced to Clear</i> 626 749.1	**SPECIAL**	

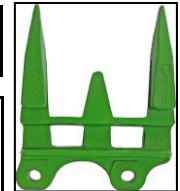



SECTIONS & FASTENERS

Part No.	Description	Midwest No.	OEM No.	HoneyBee No.	RRP \$\$ per ea
----------	-------------	-------------	---------	--------------	-----------------

SECTIONS - FOR SCHUMACHER, NEW HOLLAND, HONEYBEE ETC.

83010961	Standard Coarse Section - 10 serrations per inch	816-00055-06		26208	
83010978	Extra Coarse Section - 7 serrations per inch				
83010966	Fine Section - 14 serrations per inch				
83016222	Overlap Section - 60° Countersunk Holes	816-00052-06		62627	
83016222KIT	Overlap Section Kit with 2 x 85080012 bolts & 2 x 85013961 nuts supplied in a sealed bag				
83041752	1½ End section for HoneyBee - R/H			27159	

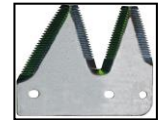
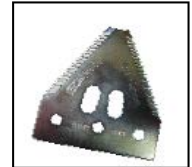

SECTIONS - FOR JOHN DEERE, MIDWEST, MACDON, ALLIS & GLEANER

83080011	Double Knife Section - John Deere	816-00062-06	RH153329		
83053293	Double Knife Section - Countersunk Holes - Midwest	116-40002-06	RH153329CS		
83041826	Standard Coarse Knife Section to suit MacDon		K343901		
83041847	Standard Knife Section to suit Allis/Gleaner (Special orders in advance only. Non-stock item)				

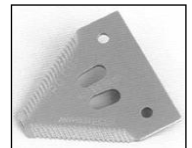

FASTENERS

85010931	Hex Head Splined Bolt - M6 x 16mm for Schumacher Sections	908-106016-1	86563537	61711	
85010067	Hex Head Bolt - M6 x 18mm for Connector Bar		86563535	61521	
85010072	Hex Head Bolt - M6 x 28mm for Knife Head/Overlap Strap		86563536	62758	
85080012	Socket Head Bolt - M6 X 16 - 60° Countersunk for Overlap Section	904-106016-1	86564364	27811	
85013961	Hex Nut - M6	913-106000-1	353308	61713	
86013016	Hex Head Bolt - M10 x 55mm for Overlap Rollers				
85012997	Hex Head Bolt - M10 x 40mm for Guards				
85013955	M10 Flange Nut for Guards & Overlap Rollers				





KNIFE KITS

Part No.	Description	Midwest No.	OEM No.	HoneyBee No.	RRP \$\$ per ea
OVERLAP KIT - FOR SCHUMACHER & STANDARD KNIVES					
86561400	Overlap Kit for Twin Knife <i>*Includes:- Overlap strap x 1, overlap section x 6, pan head bolt x 12, 28mm bolt x 3, M6 nut x 15</i>		86561400	68141	
82013665	Overlap Strap Only - 376mm				
CONNECTOR KIT - FOR SCHUMACHER & STANDARD KNIVES					
82016831	Connector Kit - 10 holes <i>Easy Cut II</i> <i>*Includes:- Connector bar x 1, Standard coarse sections x 3, 18mm bolts x 10</i>				
85010937	Threaded Inserts M6 - Connector Bars				
KNIFE REPAIR KIT - FOR SCHUMACHER & STANDARD KNIVES					
87068142	Knife Repair Kit <i>*Includes:- Connector kit x 1, standard sections x 3, 16mm splined bolt x 12, M6 nut x 12</i>				



Connector Kit

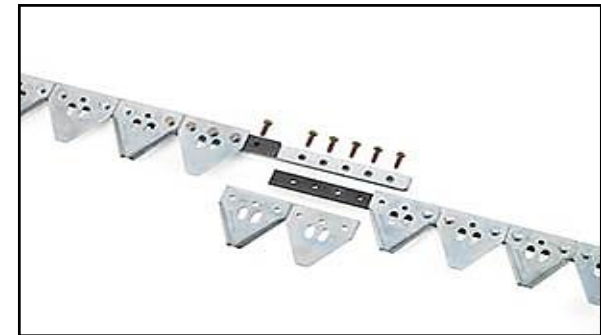



KNIFE SEGMENTS - For Knife Sets

Part No.	Description	Full length	RRP \$\$ per ea
SCHUMACHER SEGMENTS for Schumacher		<u>1 section up/1 section down - nuts down</u>	
87014652	Left Head Segment - 32 sections assembled - 4½" (3 holes) free for connector kit	8' 4½"	
87016294	Right Head Segment - 32 sections assembled - 4½" (3 holes) free for connector kit	8' 4½"	
<i>*Schumacher head segments come standard with a whole section at the knife head end.</i>			
87014653	Mid Segment - 27 sections assembled - 4½" (3 holes) free for connector kit	7' 6"	
87014655	End Segment - 26 sections assembled - 4½" (3 holes) free for connector kit	6' 10½"	
STANDARD SEGMENTS - for Crary, NH, H/Bee etc.		<u>all sections up - nuts up</u>	
87914652	Left Head Segment - 32 sections assembled - 4½" (3 holes) free for connector kit	8' 4½"	
87916294	Right Head Segment - 32 sections assembled - 4½" (3 holes) free for connector kit	8' 4½"	
<i>*Standard head segments come standard with a whole section at the knife head end.</i>			
87914653	Mid Segment - 27 sections assembled - 4½" (3 holes) free for connector kit	7' 6"	
87914655	End Segment - 26 sections assembled - 4½" (3 holes) free for connector kit	6' 10½"	
87915410	Knifeback only - 21mm x 6mm x 3 mtr		
87919163	Knifeback only - John Deere Twin x 3mtr for 4" Sections - suits JD 900 Series		

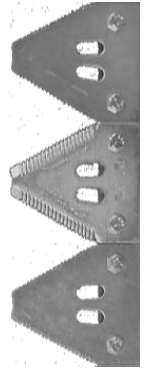

SCHUMACHER

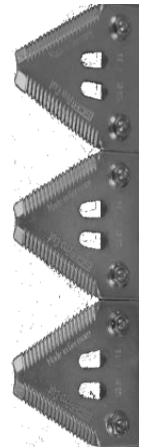

STANDARD



REPLACEMENT KNIFE SETS

These sectional Knife Sets can be used to replace OEM knife sets: HoneyBee, AGCO, MidWest, Case-IH, New Holland, MacDon etc.

**Head segments come standard with a whole section at the knife head end.*

* Knife sets listed below **DO NOT** include guards, rollers or knife heads (refer to Conversion Kits Page 7) and need to be trimmed to length.

Part No.	Knife Length	Description	OEM No.	RRP \$\$ per ea
SCHUMACHER SINGLE DRIVE			<i>1 section up/1 section down - nuts down</i>	
87010021	21'	Sectional Schumacher Knife	86561691	
87010025	25'	Sectional Schumacher Knife	86561278	
87010030	30'	Sectional Schumacher Knife	86561011	
87010036	36'	Sectional Schumacher Knife	86561332	
87010039	39'	Sectional Schumacher Knife	86564836	
SCHUMACHER TWIN DRIVE			<i>1 section up/1 section down - nuts down</i>	
87020021	21'	Sectional Schumacher Knife		
87020025	25'	Sectional Schumacher Knife		
87020030	30'	Sectional Schumacher Knife		
87020036	36'	Sectional Schumacher Knife		
87020042	42'	Sectional Schumacher Knife		
87020045	45'	Sectional Schumacher Knife		
STANDARD SINGLE DRIVE for Crary, NH, H/Bee etc			<i>all sections up - nuts up</i>	
87910021	21'	Sectional Standard Knife		
87910025	25'	Sectional Standard Knife		
87910030	30'	Sectional Standard Knife		
87910036	36'	Sectional Standard Knife		
87910039	39'	Sectional Standard Knife		
STANDARD TWIN DRIVE for Crary, NH, H/Bee etc			<i>all sections up - nuts up</i>	
87920025	25'	Sectional Standard Knife		
87920030	30'	Sectional Standard Knife		
87920036	36'	Sectional Standard Knife		
87920042	42'	Sectional Standard Knife		
87920045	45'	Sectional Standard Knife		



SCHUMACHER

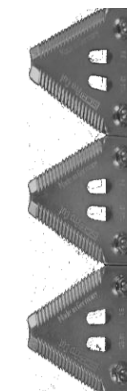

STANDARD

NOTE - OTHER SIZES ALSO AVAILABLE - POA



SCHUMACHER CONVERSION KITS

These Schumacher Conversion Kits may be used to replace some original cutting systems - eg Honeybee, MacDon etc.

The **PREMIUM** kit comes with both top and bottom rollers, while the **COMFORT** kit only has top rollers. The Comfort system can be converted to a Premium system later

The 12mm Conversion Kit includes a replacement knife (See Page 6), all guards, wearbars/spacer plates, rollers, knife head/s (only HoneyBee) and fasteners

The 14mm Conversion Kit also includes the above, EXCEPT it does not include the knife head/s.

The replacement knife will need to be trimmed to size. Other size Conversion Kits are also available - POA

Part No.	Knife Length	Description	Premium RRP per ea \$	Comfort RRP per ea \$
SCHUMACHER SINGLE DRIVE WITH 12mm GUARDS				
87011221	21'	Schumacher Conversion Kit with knife - Single Drive - 12mm Guards		
87011225	25'	Schumacher Conversion Kit with knife - Single Drive - 12mm Guards		
87011230	30'	Schumacher Conversion Kit with knife - Single Drive - 12mm Guards		
87011236	36'	Schumacher Conversion Kit with knife - Single Drive - 12mm Guards		
87011239	39'	Schumacher Conversion Kit with knife - Single Drive - 12mm Guards		
SCHUMACHER TWIN DRIVE WITH 12mm GUARDS				
87021221	21'	Schumacher Conversion Kit with knife - Twin Drive - 12mm Guards		
87021225	25'	Schumacher Conversion Kit with knife - Twin Drive - 12mm Guards		
87021230	30'	Schumacher Conversion Kit with knife - Twin Drive - 12mm Guards		
87021236	36'	Schumacher Conversion Kit with knife - Twin Drive - 12mm Guards		
87021239	39'	Schumacher Conversion Kit with knife - Twin Drive - 12mm Guards		
87021240	40'	Schumacher Conversion Kit with knife - Twin Drive - 12mm Guards		
87021242	42'	Schumacher Conversion Kit with knife - Twin Drive - 12mm Guards		
87021245	45'	Schumacher Conversion Kit with knife - Twin Drive - 12mm Guards		
SCHUMACHER SINGLE DRIVE WITH 14mm GUARDS - <u>Does not include knife head</u>				
87011425	25'	Schumacher Conversion Kit with knife - Single Drive - 14mm Guards		
87011430	30'	Schumacher Conversion Kit with knife - Single Drive - 14mm Guards		
87011435	36'	Schumacher Conversion Kit with knife - Single Drive - 14mm Guards		
SCHUMACHER TWIN DRIVE WITH 14mm GUARDS - <u>Does not include knife heads</u>				
87021425	25'	Schumacher Conversion Kit with knife - Twin Drive - 14mm Guards		
87021430	30'	Schumacher Conversion Kit with knife - Twin Drive - 14mm Guards		
87021435	36'	Schumacher Conversion Kit with knife - Twin Drive - 14mm Guards		
87021440	40'	Schumacher Conversion Kit with knife - Twin Drive - 14mm Guards		
87021445	45'	Schumacher Conversion Kit with knife - Twin Drive - 14mm Guards		

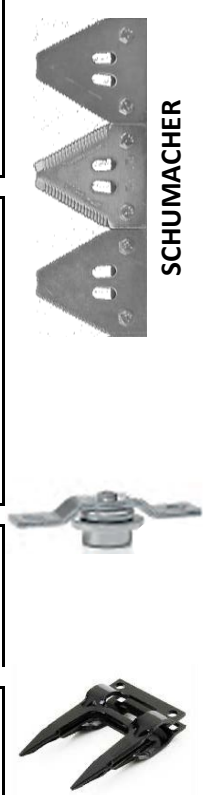

When ordering, stipulate if you want the Premium or Comfort system



WEARBARS, ROLLERS & SPACER PLATES

Part No.	Description	Length	Colour	OEM No.	HoneyBee No.	RRP \$\$ per ea
WEARBARS						
82010725	4 Hole Wearbar - 4mm thick	300mm	Grey			<i>Priced to Clear</i>
82010727	4 Hole Wearbar - 6mm thick	300mm	Black	86591628	61528	
82010741	4 Hole Wearbar - 4mm thick <i>Easy Cut II</i>	256mm	Grey			<i>Priced to Clear</i>
82010742	4 Hole Wearbar - 5mm thick <i>Easy Cut II</i>	256mm	Blue			<i>Priced to Clear</i>
82010743	4 Hole Wearbar - 6mm thick <i>Easy Cut II</i>	256mm	Black			<i>Priced to Clear</i>
82017956	4 Hole Wearbar - 7mm thick <i>Easy Cut II</i>	256mm	Black			
ROLLERS						
82016330	Bridge Roller Unit - Top - <i>New Style 19035</i>			19035		
82015768	Bridge Roller Unit - Bottom - <i>New Style 19036</i>			19036	27695	
82016004	Bridge Roller Unit - Overlap (used on twin systems)				27744	
82010662	Spacer - 14mm (for overlap rollers)				27752	
SPACER PLATES						
82015812	6 Hole Spacer Plate - 4mm thick		Grey			<i>Priced to Clear</i>
82015815	6 Hole Spacer Plate - 5mm thick		Blue			**Special**
82015816	2 Hole Spacer Plate - 6mm thick		Black			**Special**
82016494	4 Hole Spacer Plate - 6mm thick		Black			
82015818	6 Hole Spacer Plate - 6mm thick		Black			
82017472	6 Hole Spacer Plate - 7mm thick		Black			





KNIFE HEADS & COMPONENTS

Part No.	Description	Midwest No.	OEM No.	HoneyBee No.	RRP \$\$ per ea
KNIFE HEADS					
82014226	HoneyBee Left - to suit Schumacher knife		86561690	67889	
82014227	HoneyBee Right - to suit Schumacher knife		86561826	68790	
82077605	HoneyBee Right - to suit "Crary/Standard" knife				
82077606	HoneyBee Left - to suit "Crary/Standard" knife				
82015000	Midwest Left - to suit Schumacher knife				
82015010	Midwest Right - to suit Schumacher knife				
82314066	MacDon 2042 & 2052 Left - MacDon Wobble Box to Schumacher knife				
82316653	MacDon 2042 & 2052 Left - MacDon Wobble Box to MacDon knife				**Special**



KNIFE HEAD COMPONENTS					
82012543	Knife Head Nylon Insert	816-00057-06	86563534	25297	
82011233	Knife Head Eye Ring - <i>weld on type.</i>	816-00056-06			
85010941	Knife Head Serrated Inserts				
82011238	Left Hand Full Section Knife Head Bar (1pair)				





SCHUMACHER PRO DRIVES & COMPONENTS

Part No.	Description	Midwest No.	New Holland No.	HoneyBee No.	RRP \$\$ per ea
----------	-------------	-------------	-----------------	--------------	-----------------

PRO DRIVES - VERTICAL KNIFE DRIVE

87012509MW	Belt Driven Pro Drive, 85mm stroke - Midwest <i>*No Pulley - Non-Modular Type</i>	816-00049-06			
87015157	Belt Driven Modular Pro Drive used on John Deere 900 series draper fronts - same as 87014869JD <i>*with pulley fitted and 27mm block & bearing supplied.</i>				
87014869	Belt Driven Modular Pro Drive suits New Holland, HoneyBee etc (17mm Block)				
88012802	Pulley 240mm diameter				
JD21086	*New* Suits John Deere Vertical Pro-Drive to suit 600 & 700 Series Draper Fronts <i>Refer DE21086</i>		*New*		



PRO DRIVES - HORIZONTAL KNIFE DRIVE

87015744	Horizontal Hydraulic Driven Pro Drive, 85mm stroke <i>* with Hydraulic Adapter Boss (31.75mm diameter keyway)</i> <i>Suits following fronts. 92C & 94C, SP30, SP36, DHX 1&2 Series</i>		87018595	26393	
----------	--	--	----------	-------	--



PRO DRIVE COMPONENTS

87015168	Crankshaft half kit 27mm				
87015928	Crankshaft half kit 17mm				
82002603	17mm Knife Head Block & Bearing Assy (Knife Head Connector)	816-00048-06	86564390	26246	
82002601	27mm Knife Head Block & Bearing Assy (Knife Head Connector)				
82012767	27mm Knife Head Block & Bearing Assy. - longer type (Knife Head Connector)* <i>*use with JD 900 series fronts - serial number 710100 and less.</i>				
82010259	Knife Head Bearing including Top Plate (Connector Bearing)	884-05225-01	86565872	26258	
82012543	Knife Head Nylon Insert	816-00057-06	86563534	25297	
88012563	Hydraulic Adapter Boss (31.75mm diameter keyway)				





SCHUMACHER CROPLIFTERS

The Schumacher croplifter is available to suit most finger guards used in Australian harvesting operations. They are quick and easy to fit, increasing machine and operator efficiency at the peak of harvest. Height and/or angle adjustment is achieved quickly and easily by repositioning the spring clip to one of the three operating positions. (pictured below)

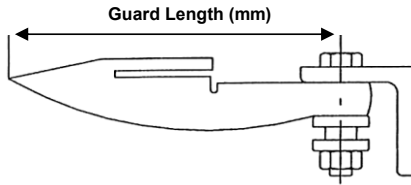

Choosing a croplifter to fit your guard

For the best fitting of the croplifter just follow these two simple steps.

1. Measure the guard length - from centre of the bolt hole to the tip of the point. (shown above)
2. Select the croplifter which best matches the guard length and choose the croplifter from the list below.

Part No.	Description	RRP \$ per ea
----------	-------------	------------------



SCHUMACHER CROPLIFTERS

Standard Croplifter

86016445	ASL100
86016587	ASL120
86016588	ASL121
86016589	ASL127



Accessories

86010237	Spring Clip
86010248	KM-3 Spool & Bolt Kit



All crop lifters must be checked once fitted for correct alignment prior to use.

CROPLIFTER FIT GUIDE

GUARD	APPROX GUARD LENGTH	CROP LIFTERS	GUARD	APPROX GUARD LENGTH	CROP LIFTERS
JOHN DEERE		Note! ASL code replaces ASK code	NEW HOLLAND		Note! ASL code replaces ASK code
H145791	135	ASK 100 / ASK120	86521587	165	ASK 127
H153719	135	ASK 100 / ASK120	379720	160	ASK 127
H206177	155	ASK120 / ASK121	215-RS	160	ASK 127
			86615982	160	ASK 127
CASE IH			MACDON		
633098R1	140	ASK 100	118344	150	ASK 120 / ASK127
1307299C2	150	ASK121 / ASK 127			
44104500	150	ASK121 / ASK 127	CLAAS		
1326787C3	150	ASK121 / ASK 127	676235.3	160	ASK 127
84442877	150	ASK121 / ASK 127			
SCHUMACHER			PRIMARY SALES		
84010616	145	ASK100 / ASK121	QUAD GUARD	150	ASK100 / ASK 120
"CRARY"					
84007228	150	ASK127			
<p>Disclaimer : This chart is for standard operating systems. All crop lifters must be checked once fitted for correct alignment prior to use.</p>					

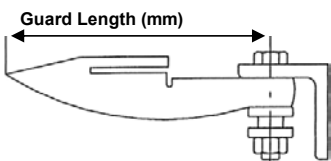



SCHUMACHER PRO FLEX PULSE CROP LIFTERS

PRO FLEX LIFTER
by SCHUMACHER.

FOR FLEX FRONTS ONLY

PRO FLEX LIFTER
by SCHUMACHER.

This NEW crop lifter from Schumacher is designed for all pulse crops. The fully adjustable lifter fits most guards. The replacement finger means you no longer need to replace the entire crop lifter.

With the specially designed slot, the PRO FLEX lifter can fit perfectly on most types of guards. That's why the Schumacher pulse lifter guarantees a tight fit. Suitable for those hard to fit fronts eg MacDon D60, 2152
Ideal for all pulse crops



5 good reasons for PRO FLEX

- 1 Schumacher pulse lifters guarantee a tight fit on all popular guards
- 2 Crop lifter finger can be easily seen in the crop due to white colored material
- 3 High quality lifter finger ensures longer life and reduced distortion
- 4 Crop lifter finger is adjustable in length
- 5 Finger angle is also adjustable

PRO FLEX LIFTER
by SCHUMACHER.



Part No.	Pro Flex Croplifter	RRP \$\$ per ea
86017646	PRO FLEX Pulse Crop lifter, including spacer & finger	
86017937	PRO FLEX Replacement Finger	
Part No.	Pro Flex Mounting Kits	RRP \$\$ per pack*
TO SUIT -		
86080178	Guards & Skids <i>with</i> square hole. eg. - Crary, Schumacher, NH	
86080179	Guards & Skids <i>with</i> round hole. eg. JD LSL/SLS	
86080180	MacDon with skids & headers with plow bolts	
*Note - each pack contains 10 Mounting Kits		

SCHUMACHER PRO FLEX MOUNTING KITS

86080178 - FOR GUARDS & SKIDS WITH SQUARE HOLES

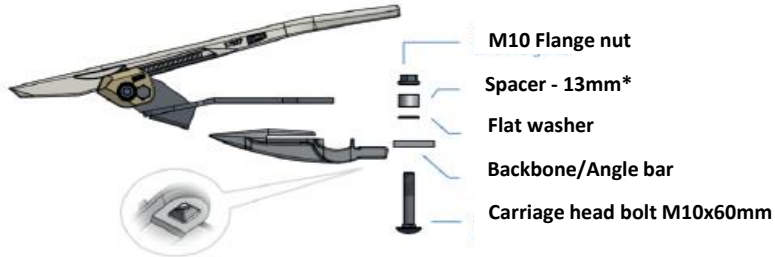

* The 13mm spacers are supplied with the *Pro Flex Croplifters*

On some applications you may have to add flat washers to achieve an even height - see mounting instructions.

86080179 - FOR GUARDS & SKIDS WITHOUT SQUARE HOLES



* The 13mm spacers are supplied with the *Pro Flex Croplifters*

On some applications you may have to add flat washers to achieve an even height - see mounting instructions.

86080180 - FOR MACDON HEADER WITH SKID SHOES

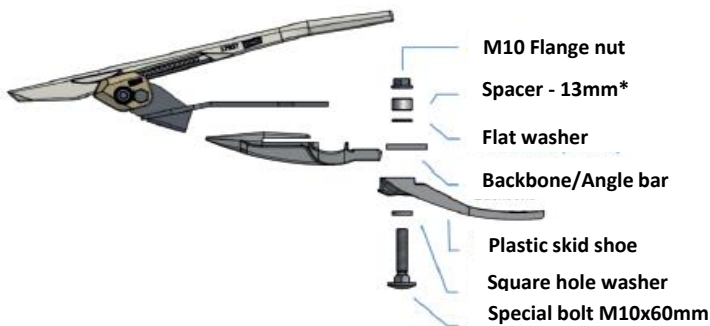

* The 13mm spacers are supplied with the *Pro Flex Croplifters*

On some applications you may have to add flat washers to achieve an even height - see mounting instructions.

86080180 - FOR HEADER WITH PLOW BOLTS (Do not need square hole washer)

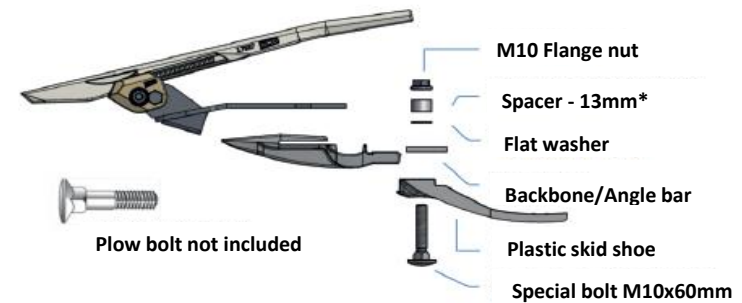

* The 13mm spacers are supplied with the *Pro Flex Croplifters*

On some applications you may have to add flat washers to achieve an even height - see mounting instructions.

NOTE - PRO FLEX MOUNTING KITS ARE SUPPLIED IN PACKS OF 10 ie 1 PACK CONTAINS 10 MOUNTING KITS



PRO FLEX CROPLIFTER MOUNTING INSTRUCTIONS

PRO FLEX LIFTERS ARE ONLY SUITABLE FOR FLEX FRONTS

INFORMATION

Due to diverse header types, different mounting kits are available. Refer to the Mounting Kits page for the correct kit, or for more information, go to:

www.agpoint.com.au

www.schumacher-original.com

PRO FLEX LIFTER
by SCHUMACHER

STEP 1

Remove bolts

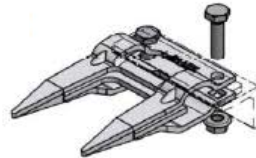

Remove existing bolts. It is recommended that you mount one *Pro Flex* croplifter on every 4th guard tip (every second guard)

STEP 2

Mount croplifter

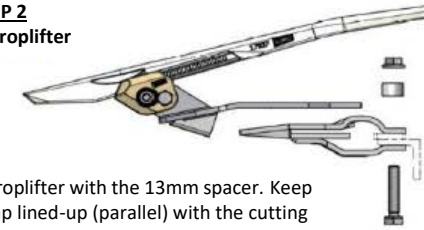

Mount the croplifter with the 13mm spacer. Keep the lifter strap lined-up (parallel) with the cutting gap on the guard

You may need to add flat washers on some guards

STEP 3

Push lifter all the way in, tighten nuts to 45Nm (33ft/lb)

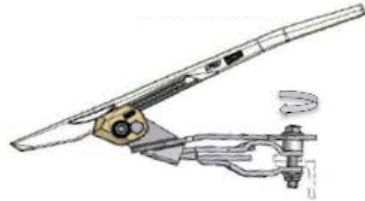

STEP 4

To change the angle, undo nuts on both sides

Undo left and right side nuts

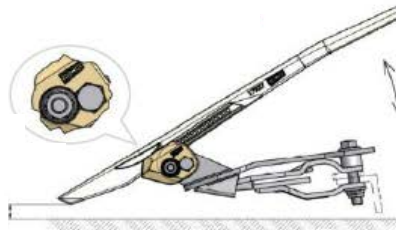

15-20mm

STEP 5

To change length, undo one nut only

Undo either left or right nut

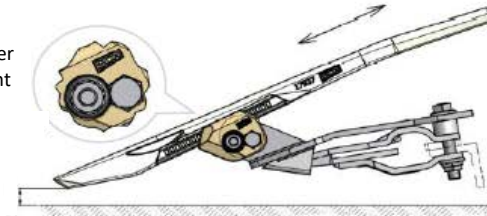

15-20mm

PRO FLEX LIFTER
by SCHUMACHER

General mounting instructions for *Pro Flex* croplifter, dependant on guard and Mounting Kit

Mount croplifters (usually every 4th guard tip or every 2nd guard) and lower the header front to working position. Adjust the croplifters to get a 15-20mm clearance with the ground (approx width of a thumb) as shown below.

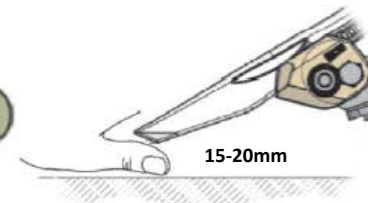
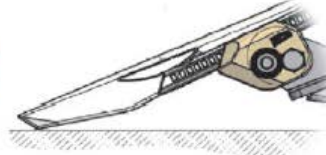
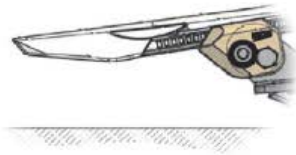

15-20mm

SCH
GEBR. SCHUMACHER

MOWER BLADE CONFIGURATION CHART

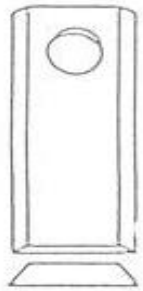

Form 1

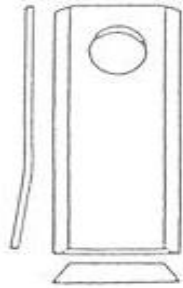

Form 2

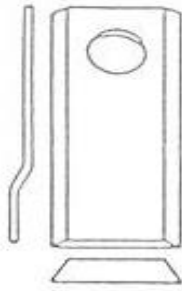

Form 3

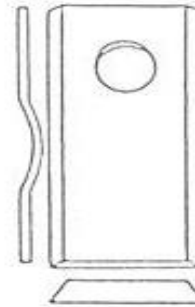

Form 4

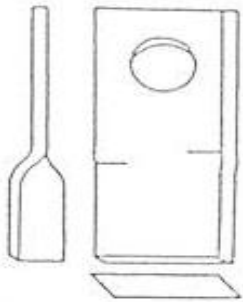

Form 5



Form 6

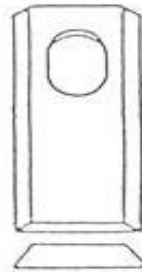

Form 7

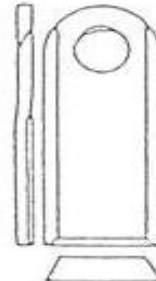

Form 8

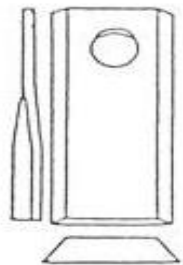

Form 9

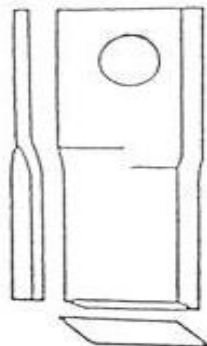

Form 10



Form 12

Rasspe Mower Blades are made in Solingen, Germany. Solingen is renowned as the capital of knife and blade manufacture; many consider that the world's best blades come from Solingen. Rasse has over 170 years of manufacturing experience and today supplies blades for mowers, straw choppers, fodder mixers and Twine Knotters for late model Balers to the major O.E.M.s of Europe.

Rasspe is proud to be part of the Schumacher Group.



Issue Date 1st June 2023, Replaces all previous updates - prices are EXCLUSIVE of GST

BOLT KITS FOR MOWERS & MOWER CONDITIONERS



42129



51027



42121



42095



42112

Part No.	BOSS Dia.	BOSS Height	Flats	Thread	To Suit	OEM NUMBERS	Bare Co.	RRP \$	Bulk price	
									1-7 Boxes	8 Boxes
51027	16mm	6.5mm	10.00mm	M10	U.F.O.	43A / 42A	B7903			
42121	18mm	10.00mm	12.00mm	M12	N. H. / KUHN J.D.	697552 / 56115800KF CC19989 + DC19765	B7336			
42095	18mm	8.5mm	N/A ****	M10	VICON - EFI	81160K	B5411			
	Off Centre/Eccentric Thread									
42129	18mm	6.5mm	12.00mm	M12	KRONE	143229.0 /1377-26-6-K	B5413			
42112	20mm	5.0mm	12.00mm	M12	TAARUP KUHN UFO 3310	56403000KF / 561501800KF	B5381			

Issue Date 1st June 2023, Replaces all previous updates & all prices are EXCLUSIVE OF GST

BLADES FOR MOWERS & MOWER CONDITIONERS

JOHN DEERE

Blade Style	Part No.		DIMENSIONS (MM)				COMMON MODELS	Bare No.	OEM Number	RRP \$	RRP \$	
			Hole Diam.	Length	Width	Th					1-7 Box	8+Boxes
9	41926	Left	16.25	95	45	4	1320, 1326, 1327, 240, 260	B5392	CC20500 CC44007			
9	41928	Right	16.25	95	45	4		B5393	CC20501 CC44006			
9	42022	Left	18.2	107	45	4	910, 915, 916, 920, 925, 926, 930, 935, 936, 945, 946, 955, 956, 990, 994, 995, 1350, 1360, 1460, 1470, (265 & 275 with serial Number breaks)	B7055	CC26780 E80206			
9	42026	Right	18.2	107	45	4		B7056	CC26781 E80208			
6	42072	Flat	18.2	130	50	4			CC19993 CC19996			

CLAAS / DEUTZ - FAHR / KRONE / ZETOR / PZ

Blade Style	Part No.		DIMENSIONS (MM)				COMMON MODELS	Bare No.	OEM Number	RRP \$	RRP \$	
			Hole Diam.	Length	Width	Th					1-7 Box	8+Boxes
9	41973	Left	19	112	48	4	Claas & Krone	B5384	952 043 0 1398880			
9	41974	Right	19	112	48	4		B5383	952 042 0 1398890			
1	41874	Flat	19	90	40	3	Deutz-Fahr KM20/22, Krone, PZ MT52S	B145	977.516. 06561543 1431490 0982.15.01. 00 3202.01.03. 46 MT52S			
1	41895	Flat	21	108	46	3			B5414	105.873.0 1058.878.0		

When ordering, box quantities can be made up of multiple part numbers. Prices listed are per single blade.

BLADES FOR MOWERS & MOWER CONDITIONERS

CASE / HESSTON / MASSEY / NEW IDEA

Blade Style	Part No.		DIMENSIONS (MM)				COMMON MODELS	Bare No.	OEM Number	RRP \$	RRP \$	
			Hole Diam.	Length	Width	Th					1-7 Box	8+Boxes
9	42022	Left	18.2	107	45	4	725, 8309, 83142, 8315, NI5070, NI5512, 8850, DC515, HST 8500	B7055	700712889			
9	42026	Right	18.2	107	45	4		B7056	700712888			
10	42006	Left	18.5	107	47	4			700711858 700713983			
10	42007	Right	18.5	107	47	4			700711857 700713984			
10	42064	Left	18.5	120	48	4	3204, 3250, 3206, 3309 (With Standard Disc)	B4137	ZA526216			
10	42066	Right	18.5	120	48	4		B4138	ZA526215			
10	42055	Left	23	110	50	4	MDX71, MDX81, MDX91, DCX101, CX131, DCX161, RDX161		9847684			
10	42056	Right	23	110	50	4			9847683			
1	41874	Flat	19	90	40	3	Deutz-Fahr KM20/22, Krone, PZ MT52S	B145	1133937R1 3101549R1			

TAARUP

Blade Style	Part No.		DIMENSIONS (MM)				COMMON MODELS	Bare No.	OEM Number	RRP \$	RRP \$	
			Hole Diam.	Length	Width	Th					1-7 Box	8+Boxes
10	41992	Left	20.5 x 23	126	48	4	* Oblong Hole 20.5 x 23mm	B5388	56.110.900			
10	41990	Right	20.5 x 24	126	48	4		B5387	56.110.400			
6	42074	Flat	20.5 x 22.8	128	50	4	* Oblong Hole 20.5 x 22.8mm	B5403	56.110.300			

When ordering, box quantities can be made up of multiple part numbers. Prices listed are per single blade.

BLADES FOR MOWERS & MOWER CONDITIONERS

NEW HOLLAND / FORD / KUHN

Blade Style	Part No.		DIMENSIONS (MM)				COMMON MODELS	Bare No.	OEM Number	RRP \$	RRP \$	
			Hole Diam.	Length	Width	Th					1-7 Box	8+Boxes
9	41926	Left	16.25	95	45	4	442, 452, 462, GMD44, GMD55, GMD66, GMD67 (Standard Disc Models only)	B5392	NH 766726 KUHN 56151210			
9	41928	Right	16.25	95	45	4		B5393	NH 766727 KUHN 56151310			
10	42055	Left	22.7	110	50	4	615 - 617, 1409 - 1412, 1431, 1432, 1441, 1442, 2331, 2332, 2355, DCX101, DCX131, DCX161, RDX161	B4177	9847684			
10	42056	Right	22.7	110	50	4		B4178	9847683			
9	42022	Left	18.2	107	45	4	408, 412, 415, 411(s/n 711816 on), GMD400, GMD500, GMD600, GMD700, GMD800, FC250, FC300, FC350	B7055	NH 853820 KUHN 55903210			
9	42026	Right	18.2	107	45	4		B7056	NH 853819 KUHN 55903310			
1	41895	Flat	21	108	46	3	New Holland	B5414	108D			
6	42074	Flat	*	128	50	4	* Oblong Hole 20.5 x 23mm	B5403	56110300			
6	51300	Flat	*	113	50	4	* Oblong Hole 20.5 x 18.5mm		56451600 56840000			

POTTINGER

Blade Style	Part No.		DIMENSIONS (MM)				COMMON MODELS	Bare No.	OEM Number	RRP \$	RRP \$	
			Hole Diam.	Length	Width	Th					1-7 Box	8+Boxes
10	41962	Left	21	100	48	4			NR434973			
10	41963	Right	21	100	48	4			NR434974			

When ordering, box quantities can be made up of multiple part numbers. Prices listed are per single blade.

BLADES FOR MOWERS & MOWER CONDITIONERS

UFO / LELY / VICON / JF

Blade Style	Part No.		DIMENSIONS (MM)				COMMON MODELS	Bare No.	OEM Number	RRP \$	RRP \$	
			Hole Diam.	Length	Width	Th					1-7 Box	8+Boxes
1	42062	Flat	17	102	45	4	H/Duty UFO Twin Drum Maxam, Trimax	B7902	UFO 141			
10	42064	Left	18.5	120	48	4	E.F.I. Mower, Vicon CM135/165/167/205/240/247, AM2400, GMT2400, GMR2400, AM3200,	B4137	90258699			
10	42066	Right	18.5	120	48	4		B4138	90258700			
10	42006	Left	18.5	107	47	4	AM2800, CM216, CM217, CM2200, KM281 (late models), DMP2800	B6137	90261559			
10	42007	Right	18.5	107	47	4		B6138	90261560			
10	41962	Left	21	100	48	4	UFO 3310		NR331L			
10	41963	Right	21	100	48	4	UFO 3310		NR331R			
6	42072	Flat	18.2	130	50	4						

When ordering, box quantities can be made up of multiple part numbers. Prices listed are per single blade.

OLD NO.		NEW NO.	OLD NO.		NEW NO.
703509	-	42062	705501	-	41926
703591	-	51027	706501	-	42074
704107	-	42006	706601	-	41992
704801	-	42064	706701	-	41990
704901	-	42066	706801	-	42072
705107	-	42007	705601	-	41928
705401	-	41874	709101	-	51300

**PART NUMBER
CHANGES**
**OLD PART NUMBERS
TO
NEW PART NUMBERS**

OLD NO.	NEW NO.	OLD NO.	NEW NO.
709194	42121	709601	42026
709291	42095	709991	42129
709301	41973	715901	41895
709401	41974	741962	41962
709501	42022	741963	41963
709591	42112	768401	42055
709601	42026	768501	42056